

GAZELLE®

GW7030 Electric Circular Saw User Manual



General power tool safety warnings



WARNING Read all safety warnings, instructions, illustrations and specifications provided with this power tool. Failure to follow all instructions listed below may result in electric shock, fire and/or serious injury.

Save all warnings and instructions for future reference. The term "power tool" in the warnings refers to your mains-operated (corded) power tool or battery-operated (cordless) power tool.

1) Work area safety

- a) **Keep work area clean and well lit.** Cluttered or dark areas invite accidents.
- b) **Do not operate power tools in explosive atmospheres, such as in the presence of flammable liquids, gases or dust.** Power tools create sparks which may ignite the dust or fumes.
- c) **Keep children and bystanders away while operating a power tool.** Distractions can cause you to lose control.

2) Electrical safety

- a) **Power tool plugs must match the outlet. Never modify the plug in any way. Do not use any adapter plugs with earthed (grounded) power tools.** Unmodified plugs and matching outlets will reduce risk of electric shock.
- b) **Avoid body contact with earthed or grounded surfaces, such as pipes, radiators, ranges and refrigerators.** There is an increased risk of electric shock if your body is earthed or grounded.
- c) **Do not expose power tools to rain or wet conditions.** Water entering a power tool will increase the risk of electric shock.
- d) **Do not abuse the cord. Never use the cord for carrying, pulling or unplugging the power tool. Keep cord away from heat, oil, sharp edges or moving parts.** Damaged or entangled cords increase the risk of electric shock.
- e) **When operating a power tool outdoors, use an extension cord suitable for outdoor use.** Use of a cord suitable for outdoor use reduces the risk of electric shock.
- f) **If operating a power tool in a damp location is unavoidable, use a residual current device (RCD) protected supply.** Use of an RCD reduces the risk of electric shock.

3) Personal safety

- a) **Stay alert, watch what you are doing and use common sense when operating a power tool. Do not use a power tool while you are tired or under the influence of drugs, alcohol or medication.** A moment of inattention while operating power tools may result in serious personal injury.

- b) **Use personal protective equipment. Always wear eye protection.** Protective equipment such as a dust mask, non-skid safety shoes, hard hat or hearing protection used for appropriate conditions will reduce personal injuries.
 - c) **Prevent unintentional starting. Ensure the switch is in the off-position before connecting to power source and/or battery pack, picking up or carrying the tool.** Carrying power tools with your finger on the switch or energising power tools that have the switch on invites accidents.
 - d) **Remove any adjusting key or wrench before turning the power tool on.** A wrench or a key left attached to a rotating part of the power tool may result in personal injury.
 - e) **Do not overreach. Keep proper footing and balance at all times.** This enables better control of the power tool in unexpected situations.
 - f) **Dress properly. Do not wear loose clothing or jewellery. Keep your hair and clothing away from moving parts.** Loose clothes, jewellery or long hair can be caught in moving parts.
 - g) **If devices are provided for the connection of dust extraction and collection facilities, ensure these are connected and properly used.** Use of dust collection can reduce dust-related hazards.
 - h) **Do not let familiarity gained from frequent use of tools allow you to become complacent and ignore tool safety principles.** A careless action can cause severe injury within a fraction of a second.
- ### 4) Power tool use and care
- a) **Do not force the power tool. Use the correct power tool for your application.** The correct power tool will do the job better and safer at the rate for which it was designed.
 - b) **Do not use the power tool if the switch does not turn it on and off.** Any power tool that cannot be controlled with the switch is dangerous and must be repaired.
 - c) **Disconnect the plug from the power source and/or remove the battery pack, if detachable, from the power tool before making any adjustments, changing accessories, or storing power tools.** Such preventive safety measures reduce the risk of starting the power tool accidentally.
 - d) **Store idle power tools out of the reach of children and do not allow persons unfamiliar with the power tool or these instructions to operate the power tool.** Power tools are dangerous in the hands of untrained users.
 - e) **Maintain power tools and accessories. Check for misalignment or binding of moving parts, breakage of parts and any other condition that may affect the power tool's operation. If damaged, have the power tool repaired before use.** Many accidents are caused by poorly

maintained power tools.

- f) **Keep cutting tools sharp and clean.** Properly maintained cutting tools with sharp cutting edges are less likely to bind and are easier to control.
- g) **Use the power tool, accessories and tool bits etc. in accordance with these instructions, taking into account the working conditions and the work to be performed.** *Use of the power tool for operations different from those intended could result in a hazardous situation.*
- h) **Keep handles and grasping surfaces dry, clean and free from oil and grease.** *Slippery handles and grasping surfaces do not allow for safe handling and control of the tool in unexpected situations.*

5) Service

- a) **Have your power tool serviced by a qualified repair person using only identical replacement parts.** *This will ensure that the safety of the power tool is maintained.*

Additional safety instructions for circular saws

Safety instructions for all saws

Cutting procedures

- a) **DANGER: Keep hands away from cutting area and the blade. Keep your Second and on auxiliary handle, or motor housing.** *If both hands are holding the saw, they can not be cut by the blade.*
- b) **Do not reach underneath the workpiece.** *The guard cannot protect you from the blade below the workpiece.*
- c) **Adjust the cutting depth to the thickness of the workpiece.** *Less than a full tooth of the blade teeth should be visible below the workpiece.*
- d) **Never hold the workpiece in your hands or across your leg while cutting. Secure the workpiece to a stable platform.** *It is important to support the work properly to minimise body exposure, blade binding, or loss of control.*
- e) **Hold the power tool by insulated gripping surfaces, when performing an operation where the cutting tool may contact hidden wiring or its own cord.** *Contact with a "live" wire will also make exposed metal parts of the power tool "live" and could give the operator an electric shock.*
- f) **When ripping, always use a rip fence or straight edge guide.** *This improves the accuracy of cut and reduces the chance of blade binding.*
- g) **Always use blades with correct size and shape (diamond versus round) of arbour holes.** *Blades that do not match the mounting hardware of the saw will run off-centre, causing loss of control.*
- h) **Never use damaged or incorrect blade washers or bolt.** *The blade washers and bolt were specially designed for your saw, for optimum performance*

and safety of operation.

Further safety instructions for all saws

Kickback causes and related warnings

- kickback is a sudden reaction to a pinched, jammed or misaligned saw blade, causing an uncontrolled saw to lift up and out of the workpiece toward the operator;
 - when the blade is pinched or jammed tightly by the kerf closing down, the blade stalls and the motor reaction drives the unit rapidly back toward the operator;
 - if the blade becomes twisted or misaligned in the cut, the teeth at the back edge of the blade can dig into the top surface of the wood causing the blade to climb out of the kerf and jump back toward the operator.
- Kickback is the result of saw misuse and/or incorrect operating procedures or conditions and can be avoided by taking proper precautions as given below.
- a) **Maintain a firm grip with both hands on the saw and position your arms to resist kickback forces. Position your body to either side of the blade, but not in line with the blade.** *Kickback could cause the saw to jump backwards, but kickback forces can be controlled by the operator, if proper precautions are taken.*
 - b) **When blade is binding, or when interrupting a cut for any reason, release the trigger and hold the saw motionless in the material until the blade comes to a complete stop. Never attempt to remove the saw from the work or pull the saw backward while the blade is in motion or kickback may occur. Investigate and take corrective actions to eliminate the cause of blade binding.**
 - c) **When restarting a saw in the workpiece, centre the saw blade in the kerf so that the saw teeth are not engaged into the material.** *If a saw blade binds, it may walk up or kickback from the workpiece as the saw is restarted.*
 - d) **Support large panels to minimise the risk of blade pinching and kickback.** *Large panels tend to sag under their own weight. Supports must be placed under the panel on both sides, near the line of cut and near the edge of the panel.*
 - e) **Do not use dull or damaged blades.** *Unsharpened or improperly set blades produce narrow kerf causing excessive friction, blade binding and kickback.*
 - f) **Blade depth and bevel adjusting locking levers must be tight and secure before making the cut.** *If blade adjustment shifts while cutting, it may cause binding and kickback.*
 - g) **Use extra caution when sawing into existing walls or other blind areas.** *The protruding blade may cut objects that can cause kickback.*

UK power plug warnings:

Your product is fitted with an BS 1363-1 approved electric plug with internal fuse approved to BS 1362. If the plug is not suitable for your socket, it should be removed and an appropriate plug should be fitted in its place by an authorized customer service agent. The replacement plug should have the same fuse rating as the original plug.

The severed plug must be disposed of to avoid a possible shock hazard and should never be inserted into a mains socket elsewhere.

Symbol



WARNING



To reduce the risk of injury, user must read instruction manual



Always wear eye protection



Class II tool

TECHNICAL DATA

Model		GW7030	
Rated Power Input	W	1500	
No-load Speed	/min	5300	
Max. Cutting Depth	90°	mm	64
	45°	mm	45
Max. Cutting Angle	°	45	
Blade Size	mm	185×20(19)×1.7	
Net Weight	kg	4.1	

※Due to the continuing program of research and development, the specifications herein are subject to change without prior notice.

ADDITIONAL SAFETY RULES

• Safety Instructions

Danger:

- Keep hands away from cutting area and blade. Keep your second hand on auxiliary handle, or motor housing.
- Do not reach underneath the work.
- Adjust the cutting depth to the thickness of the workpiece.
- Do not hold the workpiece or frame it on the leg for sawing, and clamp the workpiece on a stable platform.
- Hold tool by insulated gripping surfaces when performing an operation where the cutting tool may contact hidden wiring or its own cord.
- When ripping always use a rip fence or straight edge guide.
- Always use blades with correct size and shape (diamond versus round) arbor holes.
- Never use damaged or incorrect blade washers or bolts.

• Further safety instructions for all operations

Causes and Precautions of Kickback:

Kickback is a sudden reaction to a pinched, bound or misaligned saw blade, causing an uncontrolled saw to lift up and out of the workpiece toward the operator; When the blade is pinched or bound tightly by the kerf closing down, the blade stalls and the motor reaction drives the unit rapidly back toward the operator;

If the blade becomes twisted or misaligned in the cut, the teeth at the back edge of the blade can dig into the top surface of the wood causing the blade to climb out of the kerf and jump back toward operator.

Kickback is the result of tool misuse and/or incorrect operating procedures or conditions and can be avoided by taking proper precautions as given below:

- Maintain a firm grip with both hands on the saw and position your body and arm to allow you to resist KICKBACK forces. The body is on either side of the tool and not aligned with the blade.
- When blade is binding, or when interrupting a cut for any reason, release the trigger and hold the saw motionless in the material until the blade comes to a complete stop. Never attempt to remove the saw from the work or pull the saw backward while the blade is in motion or KICKBACK may occur.
- When restarting a saw in the workpiece, center the saw blade in the kerf and check that saw teeth are not engaged into the material. If saw blade is binding, it may walk up or KICKBACK from the workpiece as the saw is restarted.
- Support large panels to minimize the risk of blade pinching and KICKBACK.

Large panels tend to sag under their own weight. Supports must be placed under the panel on both sides, near the line of cut and near the edge of the panel. As the figure below:

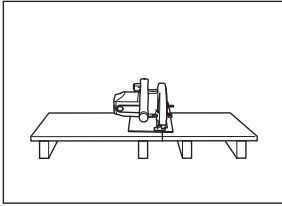

To avoid kickback, do support board or panel near the cut.

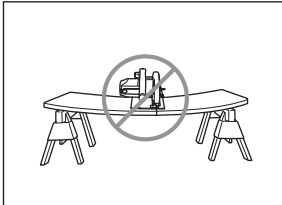

Do not support board or panel away from the cut.

- e) Do not use dull, deformed, cracked or damaged blade.
- f) Blade depth and bevel adjusting locking levers must be tight and secure before making cut.
- g) Use extra caution when making a "Plunge Cut" into existing walls or other blind areas.

Safety instructions for circular saws with swing guard

- a) Check lower guard for proper closing before each use. Do not operate saw if lower guard does not move freely and close instantly. Never clamp or tie the lower guard into the open position.
- b) Check the operation and condition of the lower guard spring. If the guard and the spring are not operating properly, they must be serviced before use.
- c) Lower guard should be retracted manually only for special cuts such as "Plunge Cuts" and "Compound Cuts". Raise lower guard by Retracting Lever. As soon as blade enters the material, lower guard must be released.
- d) Always observe that the lower guard is covering the blade before placing saw down on bench or floor.

Additional safety instructions for various circular saws with riving knife

- a) Use the appropriate riving knife for the blade being used.
- b) Adjust the riving knife as described in this instruction manual.
- c) Always use the riving knife except when plunge cutting.
- d) For the riving knife to work, it must be engaged in the workpiece.
- e) Do not operate the saw if riving knife is bent.

Additional supplements when using a circular saw

- a) When using this tool, note that:
 - The blades used shall be intact and shall not be deformed, rolled, tooth-missing or cracked;
 - Saw blades made of HSS shall not be used, and tools shall not use any grinding wheel;
 - Do not use blades that do not conform to the characteristics specified in this manual;
 - Do not apply lateral pressure on the blade disc surface to stop the blade;
 - Ensure that all the retracting mechanisms of the protection system are acting correctly;
 - Unplug the blade from the power supply before replacing the blade, making adjustments or other maintenance work.
- b) The maximum diameter of the saw blade used in this tool is 185mm
- c) The rated no-load speed of this tool is 5300r/min.
- d) Before using this tool, the blade teeth should be opened, and the size of the opening teeth should be guaranteed to be moderately kerf.
- e) When using this tool, you should control the moderate propulsion speed according to the different hardness materials.
- f) When using this tool, the processed wood shall not have foreign objects such as nails, and in the event of a hard knot of wood, the propulsion speed shall be slowed down.
- g) It is strictly forbidden to operate with the guard removed.
- h) To keep the blade clean and sharp, use sharp blades to reduce failure and rebound to a minimum.
 Danger: The hand must leave the work area when operating. Do not touch the blade. Do not insert the workpiece or touch the cut-off part when the blade is turning.
- i) Prevent rebounding safety devices
 When the circular saw suddenly decelerates, a rebound occurs, bouncing to the operator. When the saw blade is clamped by the workpiece or suddenly decelerates, the switch should be relaxed. Usually should keep the blade sharp, the operator should be shown in the figure method to support large pieces of wood. Use a locating plate for longitudinal operation. Do not force the use of tools, pay attention to work management. When saw blade is still turning, do not remove the circular saw from the workpiece. Never put your hands or fingers behind a tool. Because if a rebound occurs, the circular saw bounces easily back into the hand and can cause serious injury.
 When operating the saw, keep the cord away from the cutting area and position it so that it will not be caught on the workpiece during the cutting operation. Operate with proper hand support, proper workpiece support, and supply cord routing away from the work area.

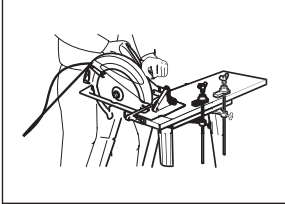
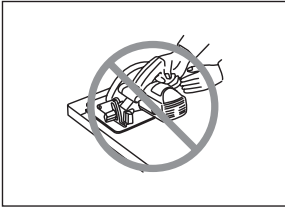

A typical illustration of proper hand support, workpiece support, and supply cord routing.

WARNING: It is important to support the workpiece properly and to hold the saw firmly to prevent loss of control which could cause personal injury. The figure below illustrates typical hand support of the saw.
j) Before sawing, you should determine whether the adjustment of the saw depth and bevel is correct.

k) When a circular saw needs to be placed on the machining part for cutting, place the tool on the larger side of the workpiece and the smaller side under the saw. Place the wider portion of the saw base on that part of the workpiece which is solidly supported, not on the section that will fall off when the cut is made. As examples, the left figure illustrates the **RIGHT** way to cut off the end of a board, and the right figure the **WRONG** way. If the workpiece is short or small, clamp it down. **DO NOT TRY TO HOLD SHORT PIECES BY HAND!**

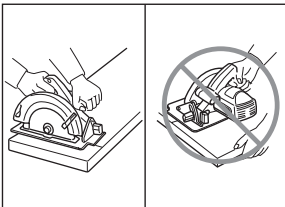

l) Never attempt to saw with the circular saw held upside down in a vise. This is extremely dangerous and can lead to serious accidents.

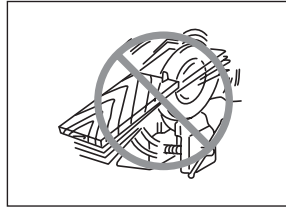

m) Before setting the tool down after completing a cut, be sure that the lower (telescoping) guard has closed and the blade has come to a complete stop.

INSTRUCTIONS FOR OPERATION

• Removing or Installing Saw Blade

The following blade can be used with this tool:

Max. Dia.	mm	185
Min. Dia.	mm	170
Inner Dia.	mm	20(19)
Thickness	mm	1.7
Kerf	mm	1.9

Caution:

Do not use saw blades that do not match the characteristics described in this manual.

• Removing Saw Blade

To remove the blade, press the spindle lock so that the blade cannot revolve and use the hex wrench to loosen the hex socket head bolt counterclockwise. And then remove the bolt, outer flange and saw blade.

***CAUTION: Always be sure that the tool is switched off and unplugged before installing or removing the saw blade.**

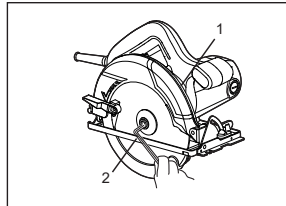

1.Lock Button
2.Hex Wrench

• Installing Saw Blade

To install the saw blade, follow the removal procedures in reverse. Install the inner flange, saw blade, outer flange and hex bolt, in that order. Be sure to secure the hex bolt clockwise tightly with the spindle lock fully depressed.

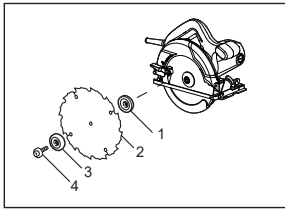

- 1.Inner Flange
- 2.Saw Blade
- 3.Outer Flange
- 4.Hex Bolt

Cautions

- Be sure the blade is installed with teeth pointing forward in the same direction as the tool rotation (the arrow on the blade should point in the same direction as the arrow on the tool).
- The inner flange is supplied for 2 types of saw blades with the inner diameters of 20 mm and 19mm. The 19 mm diameter side is marked with "19". Be sure to choose the correct side of the inner flange for installation according to the diameter of the blade. Improper installation may result in dangerous vibration and cause serious personal injury.
- Use only original wrench to remove or install the blade.

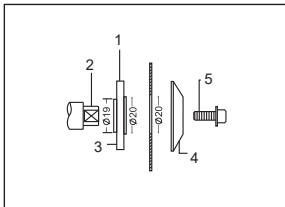

- 1.Inner Flange
- 2.Drive Spindle
- 3.Mark (19 mm)
- 4.Outer Flange Saw Blade
- 5.Hex Bolt

• Adjusting Depth of Cut

Loosen the lock lever for adjusting the cutting depth. At a desired depth of cut, secure the base by tightening the lever.

CAUTION:

Use a shallow depth of cut when cutting thin workpiece for cleaner, safer cuts. After adjusting the depth of cut, always tighten the lever securely.

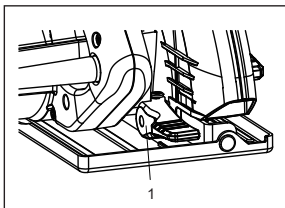

- 1.Lock Lever

• Bevel Cutting

Loosen the wing nut on the bevel gauge in front, and tilt the tool to the desired angle for bevel cut (0°-45°).

Secure the wing nut on the bevel gauge tightly after making the adjustment.

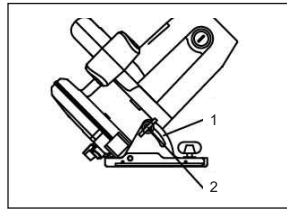

- 1.Bevel Gauge
- 2.Wing Nut

• Sighting

For straight cuts, align the right notch on the front of the base with the cutting line on the workpiece. For 45° bevel cuts, align the left notch with it.

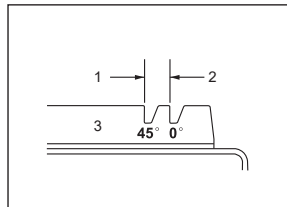

- 1.For 45° bevel cuts
- 2.For straight cuts
- 3.Base

• Switch Operation

To start the tool, first press the lock button, and pull the switch trigger. Release the switch trigger to stop.

Caution: Before plugging in the tool, always check to see that the switch trigger actuates properly and returns to the "OFF" position when released.

To prevent the switch trigger from being accidentally pulled, a lock-off button is provided as a safety feature (Anti-self-locking).

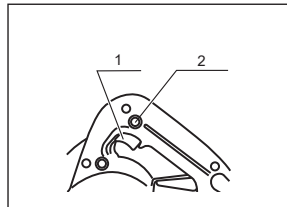

- 1.Switch Trigger
- 2.Lock Button

• Operation

Hold the tool firmly. Set the base on the workpiece to be cut without the blade making any contact. Then turn the tool on and wait until the blade attains full speed. Now simply move the tool forward over the workpiece surface, keeping it flat and advancing smoothly until the sawing is completed. To get clean cuts, keep your sawing line straight and your speed of advance uniform.

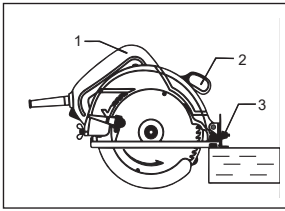

- 1.Handle
- 2.Auxiliary Handle
- 3.Base

CAUTIONS:

Do not stop the saw blade by lateral pressure on the disc.

Attempt to avoid positioning which exposes operator to chips and wood dust being ejected from saw.

Use eye protection to help avoid injury.

Rip Fence

The handy rip fence allows you to do extra-accurate straight cuts. Simply insert the guide plate to the holes of the baseplate and then secure it in position with the wing nut. It also makes repeated cuts of uniform width possible.

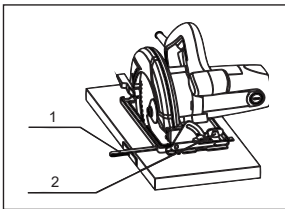

- 1.Rip Fence
- 2.Wing Nut

Vacuum installation instructions

1.As shown in the figure below, the vacuuming interface is secured to the guard by two screws.

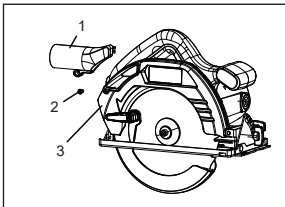

- 1.Vacuuming interface
- 2.Set Screw
- 3.Fixed Guard

2.As shown in the figure below, the vacuuming interface is mounted on the guard.

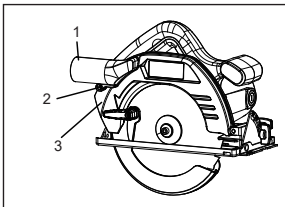

- 1.Vacuuming interface
- 2.Set Screw
- 3.Fixed Guard

3.As shown in the figure below, the vacuuming interface and the vacuum cleaner can be connected when needed.

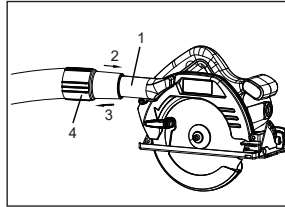

- 1.Vacuuming interface
- 2.Install
- 3.Remove
- 4.Vacuum cleaner's tube

Vacuuming instructions

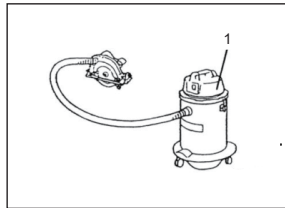

- 1.Vacuum Cleaner

MAINTENANCE AND CARE

Caution: Always be sure that the machine is switched off and unplugged before attempting to perform maintenance.

Replace the Carbon Brushes

Remove and check the carbon brushes regularly. Replace when they wear down to the limit mark. Keep the carbon brushes clean and free to slip in the holders. Both carbon brushes should be replaced at the same time.

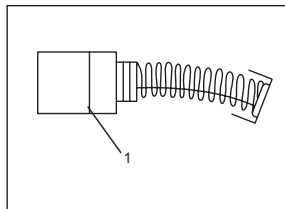

- 1.Limit Mark

Use a screwdriver to remove the brush holder caps. Take out the worn carbon brushes, insert the new ones and secure the brush holder caps.

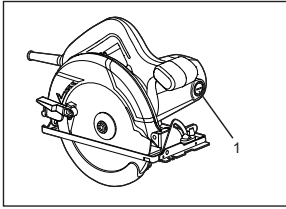

1.Brush Holder
Cap

If the replacement of the supply cord is necessary, this has to be done by the manufacturer or his agent in order to avoid a safety hazard.

Environmental Protection

Waste Disposal

The damaged tools, accessories and waste package materials should be sorted for eco-friendly recycling and in accordance with local laws.

EXPLANATION OF GENERAL VIEW

1	Hex Socket Head Bolt M6×20	33	Ball bearing 608-2RZ
3	Pan Head Screw M4×12 (with Spring Washers)	34	bearing rubber
4	Adjust Handle	35	Stator
6	lower guard	36	Cross Recessed Pan Head Tapping Screw ST5×63
7	Extension Spring (4.5×0.5×40)	39	Pan Head Screw M5×43 (with Spring and Flat Washer)
8	Circlip for Shaft 38	40	Pan Head Tapping Screw ST4.2×17
9	Bearing Holder	41	Brush Holder
10	Drive Spindle	42	Carbon Brush
11	Ball Bearing 6201DDU-DC06	43	Brush Holder Cap
12	Cross Recessed Countersunk Head Screw M5×16	44	Power Cord
13	bearing plate	45	Cord Guard
14	O-ring (40×1/Ep.)	46	Capacitor 0.22μf (Short)
15	Spacer Ring 12×18×6	47	Flange
16	Gear	48	Switch
17	Ball Bearing 606ZZ	49	Washer 6.2×15×0.5
18	pin M6	50	lock nut
19	wheel	51	Ttight-loose wrench
20	dust collect tube	52	Pan Head Tapping Screw and Flat Washer ST4.2×10
21	upper guard	53	Wing Bolt M6×20
22	Square-Neck Bolt	54	Compression Spring (8.3×1×13.5)
23	Flat Washer 6	55	Flat Washer (6.5×13×1)
24	Screw M6	56	Standard Spring Washer 6
25	rubber column	57	Elastic Cylindrical Pins6X45
26	Baffle Plate	58	Base Assembly
27	back off spring	861	Fixing Plate
28	lock lever	862	Hex Wrench (5mm)
29	Seal (25.8×29×3)	T1	Flange Set
30	Ball bearing	T2	Motor Housing Assembly
31	Armature		
32	Insulation Washer		

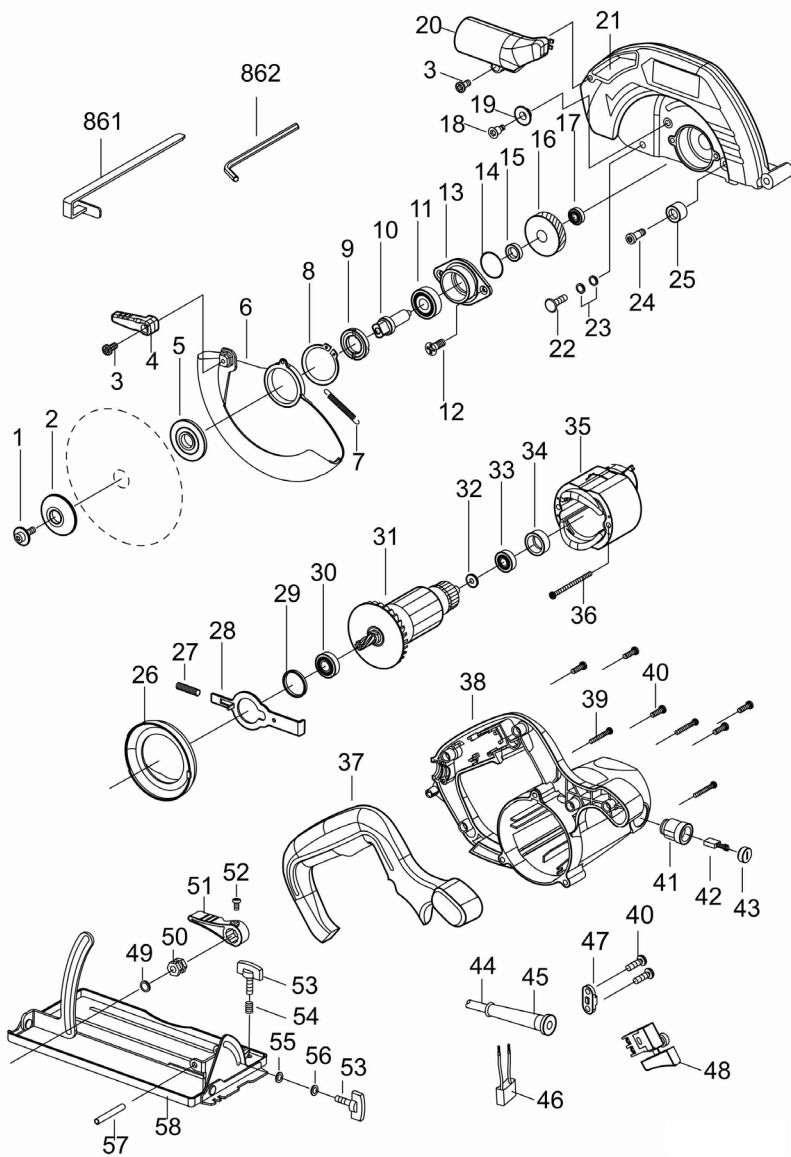

INNOVATION
PERFORMANCE
SAFETY
CONFIDENCE
GAZELLE

GAZELLE

sales@gazelleindustrial.com | www.gazelleindustrial.com