

GAZELLE[®]

GC1220

Cordless Brushless Driver Drill
User Manual



• Pictures of battery packs with different configurations vary in the illustration.

GENERAL POWER TOOL SAFETY

WARNINGS

 **WARNING** Read all safety warnings, instructions, illustrations and specifications provided with this power tool. Failure to follow all instructions listed below may result in electric shock, fire and/or serious personal injury.

Save all warnings and instructions for future reference.

The term "power tool" in the warnings refers to your mains-operated (corded) power tool or battery-operated (cordless) power tool.

1) Work Area Safety

- a) **Keep work area clean and well lit.** Cluttered or dark areas invite accidents.
- b) **Do not operate power tools in explosive atmospheres, such as in the presence of flammable liquids, gases, or dust.** Power tools create sparks which may ignite the dust or fumes.
- c) **Keep children and bystanders away while operating a power tool.** Distractions can cause you to lose control.

2) Electrical Safety

- a) **Power tool plugs must match the outlet. Never modify the plug in anyway. Do not use any adapter plugs with earthed (grounded) power tools.** Unmodified plugs and matching outlets will reduce risk of electric shock.
- b) **Avoid body contact with earthed or grounded surfaces, such as pipes, radiators, ranges and refrigerators.** There is an increased risk of electric shock if your body is earthed or grounded.
- c) **Do not expose power tools to rain or wet conditions.** Water entering a power tool will increase the risk of electric shock.
- d) **Do not abuse the cord. Never use the cord for carrying, pulling or unplugging the power tool. Keep cord away from heat, oil, sharp edges or moving parts.** Damaged or entangled cords increase the risk of electric shock.
- e) **When operating a power tool outdoors, use an extension cord suitable for outdoor use.** Use of a cord suitable for outdoor use reduces the risk of electric shock.
- f) **If operating a power in a damp location is unavoidable, use a residual current device (RCD) protected supply.** Use of an RCD reduces the risk of electric shock.

3) Personal Safety

- a) **Stay alert, watch what you are doing and use common sense when operating a power tool. Do**

not use a power tool while you are tired or under the influence of drugs, alcohol, or medication. A moment of inattention while operating power tools may result in serious personal injury.

- b) **Use personal protective equipment. Always wear eye protection.** Protective equipment such as dust mask, non-skid safety shoes, hard hat, or hearing protection used for appropriate conditions will reduce personal injuries.
 - c) **Prevent unintentional starting. Ensure the switch is in the off-position before connecting to power source and /or battery pack, picking up or carrying the tool. Carrying power tools with your finger on the switch or energising power tools that have the switch on invites accidents.**
 - d) **Remove any adjusting key or wrench before turning the tool on. A wrench or a key left attached to a rotating part of the power tool may result in personal injury.**
 - e) **Do not overreach. Keep proper footing and balance at all times.** This enables better control of the power tool in unexpected situations.
 - f) **Dress properly. Do not wear loose clothing or jewellery. Keep your hair, clothing, and gloves away from moving parts. Loose clothes, jewellery or long hair can be caught in moving parts.**
 - g) **If devices are provided for the connection of dust extraction and collection facilities, ensure these are connected and properly used. Use of dust collection can reduce dust-related hazards.**
 - h) **Do not let familiarity gained from frequent use of tools allow you to become complacent and ignore tool safety principles. A careless action can cause severe injury within a fraction of a second.**
- ### 4) Power Tool Use and Care
- a) **Do not force the power tool. Use the correct power tool for your application.** The correct power tool will do the job better and safer at the rate for which it was designed.
 - b) **Do not use the power tool if switch does not turn it on or off. Any power tool that cannot be controlled with the switch is dangerous and must be repaired.**
 - c) **Disconnect the plug from the power source and/or the battery pack from the power tool before making any adjustments, changing accessories, or storing power tools.** Such preventive safety measures reduce the risk of starting the power tool accidentally.
 - d) **Store idle power tools out of the reach of children and do not allow persons unfamiliar with the power tool or these instructions to operate the power tool. Power tools are dangerous in the hands of untrained users.**

- e) **Maintain power tools.** Check for misalignment or binding of moving parts, breakage of parts and any other condition that may affect the power tool's operation. If damaged, have the power tool repaired before use. *Many accidents are caused by poorly maintained power tools.*
- f) **Keep cutting tools sharp and clean.** *Properly maintained cutting tools with sharp cutting edges are less likely to bind and are easier to control.*
- g) **Use the power tool, accessories and tool bits etc. in accordance with these instructions, taking into account the working conditions and the work to be performed.** *Use of the power tool for operations different from those intended could result in a hazardous situation.*
- h) **Keep handles and grasping surfaces dry, clean and free from oil and grease.** *Slippery handles and grasping surfaces do not allow for safe handling and control of the tool in unexpected situations.*

5) Battery Tool Use and Care

- a) **Recharge only with the charger specified by the manufacturer.** *A charger that is suitable for one type of battery may create a risk of fire when used with another battery.*
- b) **Use power tools only with specifically designated batteries.** *Use of any other batteries may create a risk of injury and fire.*
- c) **When battery is not in use, keep it away from other metal objects like: paper clips, coins, keys, nails, screws, or other small metal objects that can make a connection from one terminal to another.** *Shorting the battery terminals together may cause sparks, burns, or a fire.*
- d) **Under abusive conditions, liquid may be ejected from the battery; avoid contact. If contact accidentally occurs, flush with water. If liquid contacts eyes, additionally seek medical help.** *Liquid ejected from the battery may cause irritation or burns.*
- e) **Do not use a battery pack or tool that is damaged or modified.** *Damaged or modified batteries may exhibit unpredictable behaviour resulting in fire, explosion or risk of injury.*
- f) **Do not expose a battery pack or tool to fire or excessive temperature.** *Exposure to fire or temperature above 130 °C may cause explosion.*
NOTE The temperature „130 °C“ can be replaced by the temperature „265 °F“.
- g) **Follow all charging instructions and do not charge the battery pack or tool outside the temperature range specified in the instructions.** *Charging improperly or at temperatures outside the specified range may damage the battery and increase the risk of fire.*

6) Service

- a) **Have your power tool serviced by a qualified repair person using only identical replacement parts.** *This will ensure that the safety of the power tool is maintained.*
- b) **Never service damaged battery packs.** *Service of battery packs should only be performed by the manufacturer or authorized service providers..*

Drill safety warnings

- 1) **Safety instructions for all operations**
 - a) **Hold the power tool by insulated gripping surfaces, when performing an operation where the cutting accessory or fasteners may contact hidden wiring.** *Cutting accessory or fasteners contacting a "live" wire may make exposed metal parts of the power tool "live" and could give the operator an electric shock.*
- 2) **Safety instructions when using long drill bits**
 - a) **Never operate at higher speed than the maximum speed rating of the drill bit.** *At higher speeds, the bit is likely to bend if allowed to rotate freely without contacting the workpiece, resulting in personal injury.*
 - b) **Always start drilling at low speed and with the bit tip in contact with the workpiece.** *At higher speeds, the bit is likely to bend if allowed to rotate freely without contacting the workpiece, resulting in personal injury.*
 - c) **Apply pressure only in direct line with the bit and do not apply excessive pressure.** *Bits can bend causing breakage or loss of control, resulting in personal injury.*

Battery safety warning

- a) Do not dismantle, open or shred secondary cells or batteries.
- b) Keep batteries out of the reach of children. Battery usage by children should be supervised. Especially keep small batteries out of reach of small children.
- c) Do not expose cells or batteries to heat or fire. Avoid storage in direct sunlight.
- d) Do not short-circuit a cell or a battery. Do not store cells or batteries haphazardly in a box or drawer where they may short-circuit each other or be short-circuited by other metal objects.
- e) Do not subject cells or batteries to mechanical shock.
- f) In the event of a cell leaking, do not allow the liquid to come in contact with the skin or eyes. If contact has been made, wash the affected area with copious amounts of water and seek medical advice.
- g) Do not use any charger other than that specifically provided for use with the equipment.
- h) Do not use any cell or battery which is not designed for use with the equipment.

- i) Do not mix cells of different manufacture, capacity, size or type within a device.
- j) Always purchase the battery recommended by the device manufacturer for the equipment.
- k) Keep cells and batteries clean and dry.
- l) Wipe the cell or battery terminals with a clean dry cloth if they become dirty.
- m) Secondary cells and batteries need to be charged before use. Always use the correct charger and refer to the manufacturer's instructions or equipment manual for proper charging instructions.
- n) Do not leave a battery on prolonged charge when not in use.
- o) After extended periods of storage, it may be necessary to charge and discharge the cells or batteries several times to obtain maximum performance.
- p) Retain the original product literature for future reference.
- q) Use the cell or battery only in the application for which it was intended.
- r) When possible, remove the battery from the

- equipment when not in use.
- s) Keep the cell or battery away from microwaves and high pressure.
- t) Dispose of properly.

Symbol



WARNING



To reduce the risk of injury, user must read instruction manual



Do not burn



Do not charge a damaged battery pack

TECHNICAL DATA

Type		GC1220
Rated Voltage(V ₌₌₌)		12
Max. Chucking Capacity		10mm
Max. Screw Diameter		7mm
No-Load Speed	1 st Gear	0-460 /min
	2 nd Gear	0-1600 /min
Max. Drilling Dia.	Steel	Ø10 mm
	Wood	Ø20 mm
Torque Setting Steps		20+1
Output Spindle Threads		1/2-20UNF
Max. Torque	1 st Gear	35N·m
	2 nd Gear	16N·m
Net Weight (Without battery)		0.93kg

Due to the continuing program of research and development, the specifications herein are subject to change without prior notice.

INTENDED USE

•Driving in and loosening screws.

•Drilling in wood, metal, and plastic.

a) Instructions for putting into use

- 1) Setting-up or fixing power tools in a stable position as appropriate for power tools which can be mounted on a support or fixed to a bench or the floor;

GENERAL DESCRIPTIONS

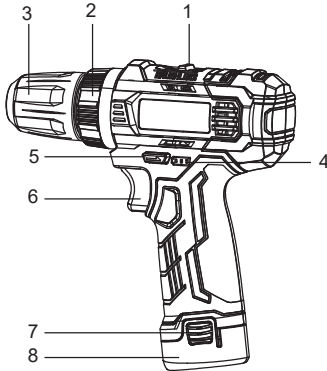

- 1.Speed Adjustment Button
- 2.Torque Setting Ring
- 3.Keyless Chuck
- 4.Battery Indicator
- 5.Reversing Slider
- 6.Switch
- 7.Battery Pack Button
- 8.Battery Pack

INSTRUCTIONS FOR OPERATION

CAUTION:

- Make sure that the AC voltage of the power source meets the requirement specified on the nameplate of the charger.
- Fully charge the battery indoors before operating the tool with it. The battery was only partially charged before leaving factory.
- Do not charge for the battery when room temperature is lower than 5°C or higher than 40°C. The battery cannot be charged when room temperature is lower than 0°C.
- A significantly reduced working period after charging indicates a used up battery that must be replaced.
- The Li-ion battery can be charged at any time without shorting its servicing life. Interrupting the charging procedure does not damage the battery.

•A battery that is new or has not been used for a long period of time does not develop its full capacity until after approximately 3-4 charging/discharging cycles.

•In a high temperature environment or after a long time of use, the machine may become hot. Please do not immediately charge the battery until it cools down.

Otherwise, the service life of the battery pack will be shortened or the battery pack will not be able to be charged due to overheating

•When charging two or more battery packs continuously, cool down the charger before charging. Otherwise, the battery may not be charged normally.

•If the charging indicator light doesn't come on immediately after the charger is plugged in, or the green light doesn't stay on after the standard charging time has passed, please consult the authorized dealer.

Plug the battery charger into the proper AC power source. The charging indicator light will flicker in green color and the charger operates in standby mode. Insert the battery pack fully into the battery charger. The charging indicator light will change from green to red and remain lit steadily during charging. When abnormality appears on the inserted battery, the charging indicator light will flicker alternately in green and red color. When the battery is fully charged, the charging indicator light will change from red to green again. After charging, unplug the charger from the power source. Hold the charger firmly and take out the battery

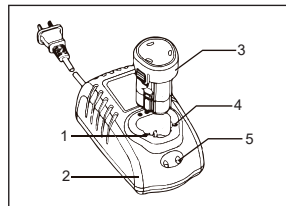

- 1.Positive Terminal
- 2.Charger
- 3.Battery Pack
- 4.Negative Terminal
- 5.Indicator Light

Installing or Removing Battery

CAUTION:

•Always switch off the tool and set the reversing switch lever to the center position before insertion or removal of the battery.

• Installing the Battery

CAUTION :

Use only the specified model battery pack. If we use other brands of battery pack, there is the risk of injury and the battery pack explosion caused by personal injury and property damage

To install the battery, Note that the battery pack is inserted correctly into the case. Be sure to insert it

until you hear "click", indicating that the battery pack is firmly installed on the machine. Otherwise, the battery pack will fall out of the case by accident and will cause the operator injury. Avoid inserting the battery pack too hard or tapping it in with the aid of other objects.

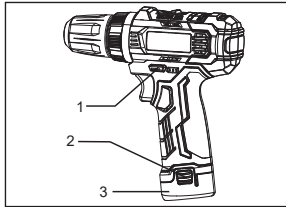

- 1.Reversing Slider
- 2.Battery Pack Button
- 3.Battery Pack

● Removing the Battery

CAUTION :

Do not force the battery pack out. The battery pack is under the machine handle, press the battery pack button on both sides, and then pull the battery pack down

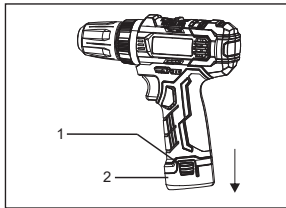

- 1.Battery Pack Button
- 2.Battery Pack

● Installing or Removing Tool

The tool here includes driver bit, drill bit, etc., which differs from the concept of power tools or machines.

CAUTION: Before operation, always set the reversing switch lever in the central position and remove the battery. And press the switch button is absolutely prohibited.

1.Installing tool

Insert the tool, turn the lock ring of the drill chuck clockwise(viewed from the front of the tool)) to tighten the tool.

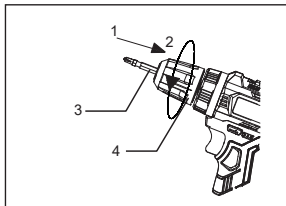

- 1.Front
- 2.Back
- 3.Instrument(Generic)
- 4.Lock Ring

2.Removing Tool

Turn the lock ring of the drill chuck counterclockwise (viewed from the front of the tool) and remove the tool.

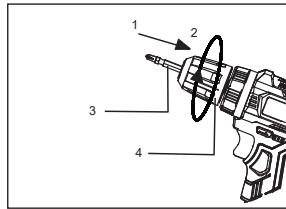

- 1.Front
- 2.Back
- 3.Instrument(Generic)
- 4.Lock Ring

● Switch Action

CAUTION:

Before inserting the battery into the tool, always check to see that the switch trigger actuates properly and returns to the "OFF" position when released.

To start the machine, just press the switch button, the speed of the machine increases with the pressure of pressing the switch button, and the machine stops when the switch button is released.

Do not operate at low speed for a long time, otherwise the machine will have overheating reaction.

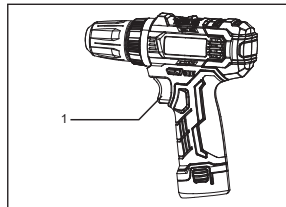

- 1.Switch Button

● Reversing Switch Action

CAUTION:

●Always check the direction of rotation before operation.

●Operate the reversing switch only after the tool comes to a complete stop. Changing the direction of rotation before the tool stops may damage the tool.

●When not operating the tool, always set the reversing switch lever to the center position.

●Never force to push the switch trigger while the reversing switch lever is set at the center position.

●The reversing switch changes the directional rotation of the tool. When the reversing switch lever is in the center position, the switch trigger cannot be pushed.

Right/Clockwise Rotation

Depress the reversing switch lever from side B to side A for clockwise rotation for drilling and driving in screws (viewed from the rear of the tool).

Left/Counterclockwise Rotation

Depress the reversing switch lever from side A to side B for counterclockwise rotation for loosening or unscrewing screws(viewed from the rear of the tool).

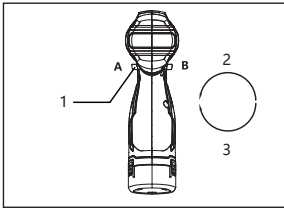

- 1.Reversing Switch Lever
- 2.Counter clockwise
- 3.Clockwise

● Speed Selection

CAUTION:

- Always keep the speed selector in a proper position. Set the selector in a position between the "1" side and the "2" side may cause damage to the tool while in operation.
 - Do not actuate the selector when the tool is running, otherwise it will cause damage to the tool.
 - If PCM protection of the tool actuates frequently to switch off the motor while setting the selector in the "2" side for high speed, reset the selector in the "1" side for low speed to continue your operation.
 - If the gear of the machine has abnormal sound and output is weak due to the collision of teeth. Please release the switch immediately, and ensure that the machine is in the no-load state, press the switch again or shift the gear again.
- To change the speed, switch off the tool firstly and then slide the selector to the "1" side for low speed or "2" side for high speed. Make sure to set the selector in a right position before operation. Choose right speed for your work.

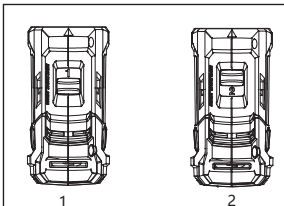

- 1.Low Velocity
- 2.High Velocity

●Battery Indicator

Recent power of the battery will be indicated by the battery indicator when pressing the switch trigger. (Fig. I) Three green LED lights are set to indicate the battery power which can be referred to the following table.

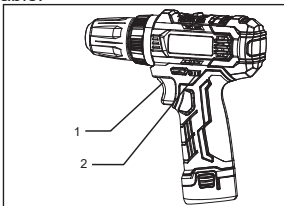

- 1.switch button
- 2.battery indicator

Status of Green LED Lights	Approx. Battery Power Left
3 lights lit	$\geq 2/3$
2 lights lit	$\geq 1/3$
1 light lit	1/3
1 light extinguished after 5 times flash	Low level

●Work Light



The white LED work light will be lit when pull the switch trigger, allows for illumination of the work area under unfavorable lighting conditions.

The white LED work light will flash one time one second when the battery near to be run out, and flash 2 times one second when the tool is overheated.

●Setting the Fastening Torque

CAUTION:

- Do not operate the tool when the pointer is positioned halfway between the number "20" and the "Drilling" symbol . Otherwise may cause damage to the tool.

The fastening torque can be adjusted in 21 steps by turning the torque setting ring so that its graduations are aligned with the pointer on the tool body. (Fig. J) The fastening torque is minimum when the number 1 is aligned with the pointer, and maximum when the "Drilling" symbol  is aligned with the pointer. The clutch will slip at various torque levels when set at the number 1 to 20, but won't slip when set at the "Drilling" symbol .

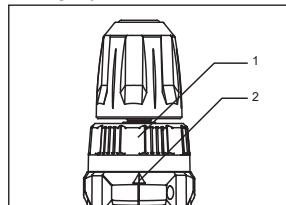

- 1.Torque Setting Ring
- 2.Pointer

●Drilling Operation

CAUTION:

- Pressing excessively on the tool will not speed up the drilling. In fact, this excessive pressure will only serve to damage the tip of your bit, decrease the tool performance and shorten the service life of the tool.
- There is a tremendous force exerted on the tool/bit at the time of hole break through. Hold the tool firmly and extra care when the bit begins to break through the workpiece.
- A stuck bit can be removed simply by setting the reversing switch to reverse rotation in order to back off. However, the tool may back off abruptly

if you do not hold it firmly.

- Always secure small workpieces in a vise or similar hold-down device.
- You are suggested to set the speed selector to the "1" side for low speed when drilling holes between Ø6-10mm.

Align the "Drilling" symbol  with the pointer when performing drilling operation.

When drilling in wood, the best results are obtained with wood drills equipped with a guide screw. The guide screw makes drilling easier by pulling the bit into the workpiece.

When drilling in metal, to prevent the bit from slipping when starting a hole, make an indentation with a center-punch and hammer at the point to be drilled. Place the point of the bit in the indentation and start drilling.

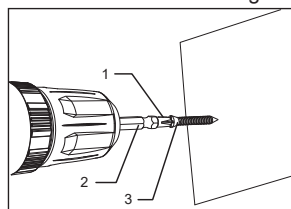

1. The point of drive bit
2. Driver Bit
3. Screwhead

• Continuous usage

If the tool is operated continuously until the battery has discharged, allow the tool to rest for 15 minutes before proceeding with a fresh battery.

• Tightening the Screws

CAUTION:

- Make sure that the driver bit is inserted straight in the screw head, or the screw and/or bit may be damaged.

Place the point of the driver bit in the screw head and apply pressure to the tool. Start the tool slowly and then increase the speed gradually. Release the switch trigger as soon as the clutch cuts in.

Nominal Diameter of Wood Screw (mm)	Recommended Size of Pilot Hole (mm)
3.1	2.0-2.2
3.5	2.2-2.5
3.8	2.5-2.8
4.5	2.9-3.2
4.8	3.1-3.4
5.1	3.3-3.6
5.5	3.7-3.9
5.8	4.0-4.2

• Removing the Screws

CAUTION:

- When the bolts are removed, the forward and reverse slip blocks are in the reverse position. Place the point of the driver bit in the screw head and apply pressure to the tool. Start the tool slowly and then increase the speed gradually. Release the switch trigger as soon as the clutch cuts in. When driving wood screws, predrill pilot holes to make driving easier and to prevent splitting of the workpiece. Refer to the following table for driving pilot holes.

• Overheated Protection

Overload is not allowed when the machine is in use. When the load is too high or the allowable battery temperature of 75°C is exceeded, the electronic control will shut off the tool until the temperature is in the optimum temperature range again.

• Deep Discharging Protection

The tool is equipped with a protective circuit to protect the battery against deep discharging. When the battery is near to be empty, the protective circuit actuates to switch off the tool.

• Disposal of Battery

Lithium ion battery is contained in the battery pack. For environmental protection, recycle or dispose of the worn out battery properly. Please consult with your local relevant departments about how to recycle and/or dispose of the worn out battery. To recycle or dispose of the worn out battery:

- Remove the battery from the tool when it is worn out.
- Wrap the terminals with a strong tape to avoid short-circuit and electric leakage.

Never attempt to disassemble or dismember the battery!

MAINTENANCE AND INSPECTION

CAUTION:

Always be sure that the tool is switched off and the battery is removed before attempting to perform inspection or maintenance.

• Cleaning Ventilation Slots

For safe and proper working, always keep the

power tool and its ventilation slots clean. Use a soft, clean and dry brush to clean the ventilation slots regularly or when they're clogged.

● **Inspecting the Mounting Screws**

Regularly inspect all mounting screws and ensure that they are properly tightened. Should any of the screws be loose, retighten them immediately. Failure to do so could result in serious hazard.

● **Cleaning**

Only use soft and dry cloth to wipe the body of the tool. Do not clean the tool with wet cloth, thinner, gasoline or other volatile solvents.

To maintain product SAFETY and RELIABILITY, repairs, any other maintenance or adjustment should be performed by authorized service centers, always using original replacement parts.

For battery tools:

Ambient temperature range during operation and storage: 0 °C - 45 °C .

Recommended ambient temperature range during charging: 5 °C - 40 °C .

	Charger	Battery Pack
Model	GC1002	GC1010

The battery packs of our company are constantly updated, please look forward to our service and latest news!

EXPLANATION OF GENERAL VIEW

1	Cross Recessed Pan Head Screw M6*20(Left)	28	Lock Shim
2	Keyless Drill Chuck	29	Planet Carrier B (13T)
3	Cross Recessed Countersunk Head Screw ST2.9X13	30	IPlanet Gear
4	Washer(321X16.3X1.5)	31	Inner Gear B
5	Adjusting Ring	32	Planet Carrier C
6	Torque Setting Nut	33	Planet Gear C
7	Spring Retainer	34	Inner Gear C
8	Torque Adjustment Spring	35	Washer 13.5×30×0.3
9	Torque Washer	36	Right Oil Sealing
10	Steel BallØ4.5	37	Pin
11	Drive Spindle	38	Rear Gear Housing
12	Deep Groove Ball Bearing 6800DDU	39	Left Oil Sealing
13	Front Gear Housing	40	Driving Gear
14	Click Spring Plate	41	Armature Assembly
15	Speed Change Assembly	42	Controller Assembly
16	Spring Holder	43	Terminal Block
17	Spring 0.4*2.7*13	44	Cross Recessed Pan Head Tapping Screw ST2.9×16
18	Speed Control Push Button	45	Reversing Switch Lever
19	Circlip for Shaft 10	46	Nameplate
20	Spindle Sleeve	47	Battery Indicator
21	Lock Pin Washer	48	Clip Board
22	Lock Pin 3.6×4.9	49	Right-half Motor Housing
23	Ring	50	Left-half Motor Housing
24	Shaft Lock Frame		
25	Planet Gear A (11T)		
26	Inner Gear A (35T)		
27	Washer 13×39×0.5		

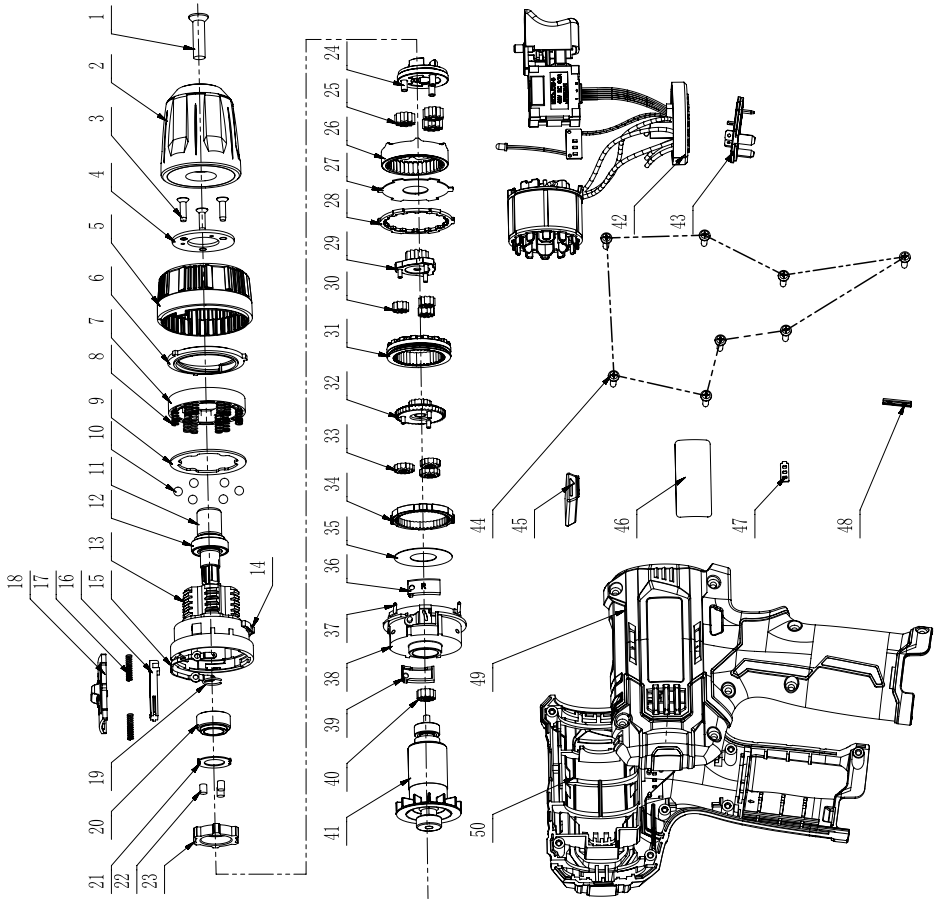

INNOVATION
PERFORMANCE
SAFETY
CONFIDENCE
GAZELLE

GAZELLE

sales@gazelleindustrial.com | www.gazelleindustrial.com